

NETSCREEN-500

User's Guide

Version 5.0

P/N 093-1214-000

Rev. B

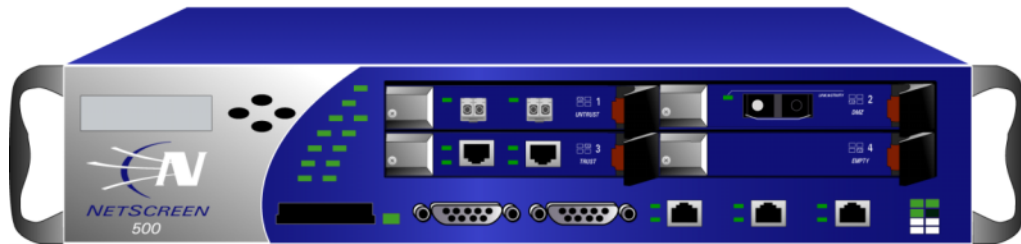

Copyright Notice

Copyright © 2005 Juniper Networks, Inc. All rights reserved.

Juniper Networks, the Juniper Networks logo, NetScreen, NetScreen Technologies, GigaScreen, and the NetScreen logo are registered trademarks of Juniper Networks, Inc. NetScreen-5GT, NetScreen-5XP, NetScreen-5XT, NetScreen-25, NetScreen-50, NetScreen-100, NetScreen-204, NetScreen-208, NetScreen-500, NetScreen-5200, NetScreen-5400, NetScreen-Global PRO, NetScreen-Global PRO Express, NetScreen-Remote Security Client, NetScreen-Remote VPN Client, NetScreen-IDP 10, NetScreen-IDP 100, NetScreen-IDP 500, GigaScreen ASIC, GigaScreen-II ASIC, and NetScreen ScreenOS are trademarks of Juniper Networks, Inc. All other trademarks and registered trademarks are the property of their respective companies.

Information in this document is subject to change without notice.

No part of this document may be reproduced or transmitted in any form or by any means, electronic or mechanical, for any purpose, without receiving written permission from:

Juniper Networks, Inc.
ATTN: General Counsel
1194 N. Mathilda Ave.
Sunnyvale, CA 94089-1206

FCC Statement

The following information is for FCC compliance of Class A devices: This equipment has been tested and found to comply with the limits for a Class A digital device, pursuant to part 15 of the FCC rules. These limits are designed to provide reasonable protection against harmful interference when the equipment is operated in a commercial environment. The equipment generates, uses, and can radiate radio-frequency energy and, if not installed and used in accordance with the instruction manual, may cause harmful interference to radio communications. Operation of this equipment in a residential area is likely to cause harmful interference, in which case users will be required to correct the interference at their own expense.

The following information is for FCC compliance of Class B devices: The equipment described in this manual generates and may radiate radio-frequency energy. If it is not installed in accordance with NetScreen's installation instructions, it may cause interference with radio and television reception. This equipment has been tested and found to comply with the limits for a Class B digital device in accordance with the specifications in part 15 of the FCC rules. These specifications are designed to provide reasonable protection against such interference in a residential installation. However, there is no guarantee that interference will not occur in a particular installation.

If this equipment does cause harmful interference to radio or television reception, which can be determined by turning the equipment off and on, the user is encouraged to try to correct the interference by one or more of the following measures:

- Reorient or relocate the receiving antenna.
- Increase the separation between the equipment and receiver.
- Consult the dealer or an experienced radio/TV technician for help.
- Connect the equipment to an outlet on a circuit different from that to which the receiver is connected.

Caution: Changes or modifications to this product could void the user's warranty and authority to operate this device.

Disclaimer

THE SOFTWARE LICENSE AND LIMITED WARRANTY FOR THE ACCOMPANYING PRODUCT ARE SET FORTH IN THE INFORMATION PACKET THAT SHIPPED WITH THE PRODUCT AND ARE INCORPORATED HEREIN BY THIS REFERENCE. IF YOU ARE UNABLE TO LOCATE THE SOFTWARE LICENSE OR LIMITED WARRANTY, CONTACT YOUR JUNIPER NETWORKS REPRESENTATIVE FOR A COPY.

Contents

| | |
|---|----|
| Preface | v |
| Guide Organization | v |
| Command Line Interface (CLI) Conventions | vi |
| Juniper Networks NetScreen Publications | vi |
| Chapter 1 Overview | 1 |
| The Front Panel | 2 |
| LCD and Control Pad Menu Interface | 2 |
| LED Dashboard | 3 |
| Interface Modules | 5 |
| The 10/100 Mbps Interface Module | 5 |
| The Gigabit Interface Connector (GBIC) Module | 6 |
| The Mini-GBIC Interface Connector Module | 6 |
| PCMCIA | 7 |
| Management Interfaces | 7 |
| High Availability Interfaces | 7 |
| The Rear Panel | 8 |
| Power Supplies | 8 |
| The Fan Module | 9 |
| Chapter 2 Installing the Device | 11 |
| General Installation Guidelines | 12 |
| Equipment Rack Mounting | 12 |
| Rack Mounting Guidelines | 12 |
| Equipment Rack Accessories and Required Tools | 13 |
| Front Mount | 14 |
| Mid-Mount | 14 |
| Rear-and-Front Mount | 15 |
| Chapter 3 Configuring the Device | 17 |
| Operational Modes | 18 |
| Transparent Mode | 18 |
| Route Mode | 18 |
| The NetScreen-500 Interfaces | 19 |
| Configurable Interfaces | 19 |
| The Ethernet Interfaces | 19 |
| Connecting to a Network | 20 |
| Connecting the NetScreen-500 as a Single Security Appliance | 20 |
| Connecting the NetScreen-500 for High Availability | 21 |
| Performing Initial Connection and Configuration | 24 |
| Establishing a Console Connection | 24 |
| Changing Your Admin Name and Password | 25 |
| Setting Interface IP Addresses | 25 |
| Viewing Current Interface Settings | 25 |
| Setting the IP Address of the Management Interface | 25 |

- Setting the IP Address for the Trust Zone Interface26
- Setting the IP Address for the Untrust Zone Interface26
- Allowing Outbound Traffic27
- Configuring the Device for Telnet and WebUI Sessions 28
 - Establishing a Telnet Connection 28
 - Establishing a Dialup Management Connection 28
 - Establishing a WebUI Management Session 29
 - Configuring the Chassis Alarm..... 29
- Performing Initial Configuration Using the Menu System 30
 - Setting Interface IP Addresses..... 30
 - Setting the MGT Interface IP Address and Netmask30
 - Setting the VLAN1 IP Address for Transparent Mode31
 - Setting Interface IP Addresses31
- Resetting the Device to Factory Default Settings 32
- Chapter 4 Servicing the Device..... 33
 - Removing and Inserting Interface Modules 34
 - Inserting Interface Modules 34
 - Removing Interface Modules 37
 - Installing Power Supplies 38
 - Wiring the DC Power Supplies..... 38
 - Replacing a DC Power Supply 39
 - Replacing an AC Power Supply 40
 - Replacing the Fan Module 41
 - Connecting and Disconnecting Gigabit Ethernet Cables 43
 - Removing and Installing a Mini-GBIC Transceiver 43
 - Removing and Installing a GBIC Transceiver 44
- Appendix A SpecificationsA-I
 - NetScreen-500 Attributes A-II
 - Electrical Specification A-II
 - Environmental A-II
 - FIPS Certification A-II
 - Safety Certifications A-II
 - EMI Certifications A-II
 - Connectors A-III
 - Sessions A-III
- Index..... IX-I

Preface

The Juniper Networks NetScreen-500 is a purpose-built, high-performance security system designed to provide a flexible solution to medium and large enterprise central sites and service providers. The NetScreen-500 security system integrates firewall, VPN, high availability, integrated networking capabilities, and traffic management functionality in a low-profile, modular chassis.

The NetScreen-500 is built around NetScreen's custom, second-generation purpose-built GigaScreen ASIC, which provides accelerated encryption algorithms and policy lookups. In addition, there are two high speed busses to off-load management traffic from application traffic processing. This prevents high availability and other management traffic from impacting throughput performance.

This manual introduces the NetScreen-500, describes how to install and service the device, and shows how to perform initial configuration. It also lists device requirements and performance specifications.

GUIDE ORGANIZATION

This manual has four chapters and one appendix.

Chapter 1, "[Overview](#)" provides a detailed overview of the system and its modules, Fast Ethernet (FE) and mini-GBIC connectors, power supplies and fan tray.

Chapter 2, "[Installing the Device](#)" details how to rack mount the NetScreen-500 device, connect the power supplies, and connect the modules to the network in addition to providing desktop site requirements and guidelines for rack mounting.

Chapter 3, "[Configuring the Device](#)" details how to obtain an IP address for an interface on one of the modules and how to aggregate ports on one of the modules.

Chapter 4, "[Servicing the Device](#)" provides procedures on how to replace your modules and power supplies.

Appendix A, "[Specifications](#)" provides a list of physical specifications about the NetScreen-500 Series, the modules, and power supplies.

COMMAND LINE INTERFACE (CLI) CONVENTIONS

The following conventions are used when presenting the syntax of a command line interface (CLI) command:

- Anything inside square brackets [] is optional.
- Anything inside braces { } is required.
- If there is more than one choice, each choice is separated by a pipe (|). For example,

```
set interface { ethernet1 | ethernet2 | ethernet3 }  
manage
```

means “set the management options for the ethernet1, ethernet2, or ethernet3 interface”.

- Variables appear in *italic*. For example:

```
set admin user name1 password xyz
```

When a CLI command appears within the context of a sentence, it is in **bold** (except for variables, which are always in *italic*). For example: “Use the **get system** command to display the serial number of a NetScreen device.”

Note: When typing a keyword, you only have to type enough letters to identify the word uniquely. For example, typing **set adm u joe j12fmt54** is enough to enter the command **set admin user joe j12fmt54**. Although you can use this shortcut when entering commands, all the commands documented here are presented in their entirety.

JUNIPER NETWORKS NETSCREEN PUBLICATIONS

To obtain technical documentation for any Juniper Networks NetScreen product, visit www.juniper.net/techpubs/.

For technical support, open a support case using the Case Manager link at <http://www.juniper.net/support/> or call 1-888-314-JTAC (within the United States) or 1-408-745-9500 (outside the United States).

If you find any errors or omissions in the following content, please contact us at the e-mail address below:

techpubs-comments@juniper.net

Overview

This chapter provides detailed descriptions of the NetScreen-500 chassis.

Topics in this chapter include:

- “The Front Panel” on page 2
 - “LCD and Control Pad Menu Interface” on page 2
 - “LED Dashboard” on page 3
 - “Interface Modules” on page 5
 - “PCMCIA” on page 7
 - “Management Interfaces” on page 7
 - “High Availability Interfaces” on page 7
- “The Rear Panel” on page 8
 - “Power Supplies” on page 8
 - “The Fan Module” on page 9

Note: For safety warnings and instructions, please refer to the NetScreen Safety Guide. The instructions in this guide warn you about situations that could cause bodily injury.

THE FRONT PANEL

The front panel of the NetScreen-500 device has the following:

- A LCD and control pad menu interface
- An LED dashboard
- Four removable, replaceable interface modules
- A PCMCIA memory card slot
- Management, Console, and Modem ports
- High-availability (HA) ports

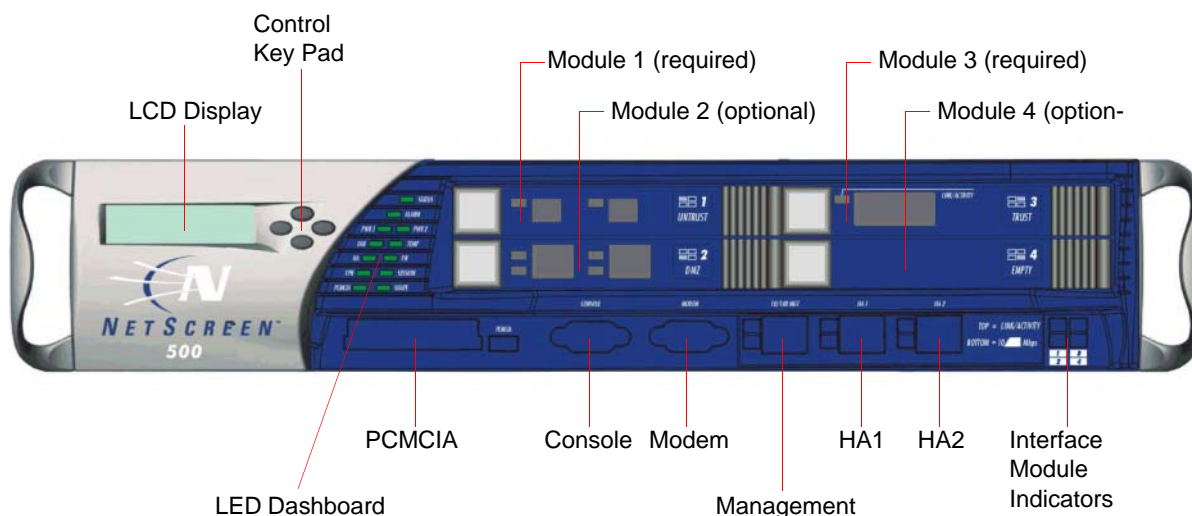

LCD and Control Pad Menu Interface

The LCD and control pad menu interface allows you to perform basic configurations and view status reports. The LCD can display two lines, each containing up to 16 characters. The control pad has four menu navigation keys (up, down, left, and right).

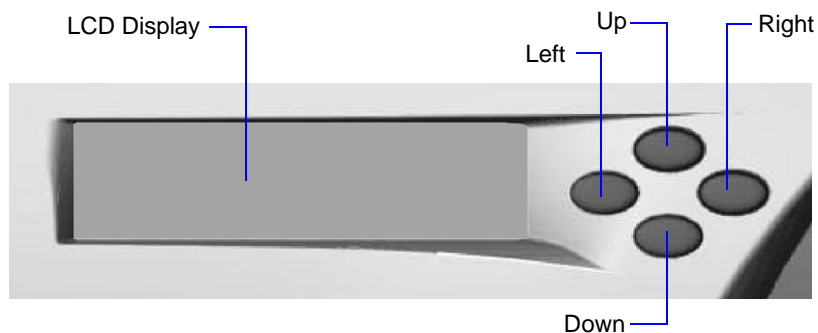

LED Dashboard

The LED dashboard displays up-to-date information about critical NetScreen-500 functions.



The information revealed by each LED is as follows:

| LED | Purpose | Color | Meaning |
|---------------|-----------------|-----------------------|---|
| STATUS | System Status | blinking green | Normal operation |
| ALARM | System Alarm | red | Critical alarm—failure of hardware component or software module (such as a cryptographic algorithm) |
| | | amber | Major alarm: Low memory (<10% remaining) High CPU utilization (>90%) Log memory full Sessions full Maximum number of VPN tunnels reached Firewall attacks detected HA status changed or redundant group member not found |
| | | green | No alarm condition present. |
| | | off | No alarms |
| PWR 1 | Power Supply #1 | green | Power supply #1 is functioning correctly. |
| | | red | Power supply #1 failure or power bay #1 is empty. |

| LED | Purpose | Color | Meaning |
|----------------|--------------------------|--|--|
| PWR 2 | Power Supply #2 | green red | Power supply #2 is functioning correctly. Power supply #2 failure or power bay #2 is empty. |
| FAN | Fan Status | green red | All fans functioning properly One or more fans failed. |
| TEMP | Temperature | green orange red | Temperature is within safety range. Temperature is outside normal alarm range. Temperature is outside severe alarm range. |
| HA | High Availability Status | green blinking green amber off | Unit is master. Redundant group member cannot be found. Unit is backup. HA not configured |
| FW | Firewall Alarm | green red | No firewall attacks Firewall event/alarm has occurred. |
| VPN | VPN Activity | blinking green blinking amber red off | VPN activity—encrypting/decrypting traffic VPN drops or denies traffic VPN tunnels have reached 90% of the maximum number of simultaneously active IPsec SAs. No VPN defined or no tunnels active |
| SESSION | Session Utilization | green amber red | Sessions are <70% utilization. Sessions are between 70% and 90% utilization. Sessions are >90% utilization. |
| PCMCIA | PC Card Status | green blinking green off | PC card is installed in PCMCIA slot. Read-write activity is detected. PCMCIA slot is empty. |
| SHAPE | Traffic Shaping | green blinking green blinking amber red off | Traffic shaping in operation Traffic shaping transmits packets Traffic shaping drops packets Configured guaranteed bandwidth > available interface bandwidth (changes to green when you correct the configuration) No traffic shaping configured |

Note: To change the Alarm LED or Firewall LED from red to green but keep the alarm message(s) in the menu system, use the CLI command **clear led { alarm | firewall }**. To change the LCD to green and remove the alarm or firewall messages, use the control pad menu keys to select **3. Alarm > 32. Clear All > Yes**.

When you apply power to the NetScreen-500 device, the Status LED changes from off to blinking green. Startup takes up to one minute to complete.

Note: If you want to turn the NetScreen-500 off and on again, wait a few seconds between shutting it down and powering it back up.

Interface Modules

The front of the NetScreen-500 device has four interface module bays. Each interface module has either one or two ports, and each port has a pair of LEDs.

Note: You can use both 10/100 Base-T and GBIC cards simultaneously for the same NetScreen-500; there are no combination restrictions. However, the cards are not hot-swappable.

The 10/100 Mbps Interface Module

The 10/100 Mbps interface module is appropriate for a 10 Base-T or 100 Base-T LAN. Connect the ports using a twisted pair cable with RJ-45 connectors. (See “[Operational Modes](#)” on page 18 for cabling guidelines.)

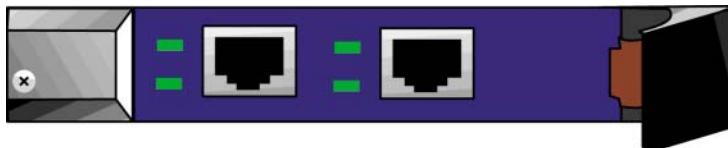

Top Status LED:

Green: Link is up, no activity
Blinking Green: Link is up and active

Bottom Status LED:

Dark: 10 Mbps line rate
Orange: 100 Mbps line rate

The Gigabit Interface Connector (GBIC) Module

The GBIC interface module provides connectivity to fiber-based, gigabit ethernet LANs. Connect the ports using an optical cable with SX or LX connectors.



Status LED:
Green: Link is up, no activity
Blinking Green: Link is up and active

The Mini-GBIC Interface Connector Module

The mini-GBIC interface module provides connectivity to fiber-based, gigabit ethernet LANs. Connect using an optical cable with SX or LX connectors.



Status LED:
Green: Link is up, no activity
Blinking Green: Link is up and active

The interface module LEDs are in the lower-right corner of the front panel. The relative position of each LED corresponds to the position of the represented module.



The color of the LED indicates the state of the interface module:

- Green: Card is operational
- Blinking Red: Card has failed
- Dark: No card

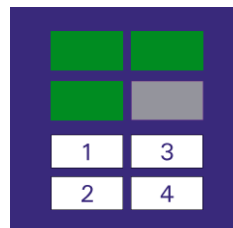

PCMCIA

The PCMCIA slot is for downloading or uploading system software or configuration files and saving log files. This slot can accept a type I, II, or III SanDisk® ATA PC card.

To perform download or upload, execute the CLI command **save**:

```
save
  { software | config }
    from { flash | slot1 filename } to
         { flash | slot1 filename }
```

where **slot1** refers to the PCMCIA slot, **flash** refers to internal flash memory, and **filename** is the name of the software or configuration file on the card.

For example, the following command downloads the current device configuration to a file named **ns500_config** on a card in the PCMCIA slot:

```
save config from flash to slot1 ns500_config
```

Management Interfaces

The NetScreen-500 device offers three management interfaces:

| Port | Description |
|-------------------|---|
| Console | This DB-9 port is for local configuration and administration using the CLI. Connect the Console port to your workstation using a DB-9 female to DB-9 male straight-through serial cable. |
| Modem | This DB-9 serial port is for connecting to a modem, allowing the user to control the device remotely. (For security reasons, it is advisable to use a modem only for troubleshooting or a one-time configuration, not for regular remote administration.) |
| 10/100 MGT | This management port has a fixed 10/100 Base-T interface and provides a dedicated, out-of-band connection for management traffic. It has a separate IP address and netmask, configurable with the CLI or WebUI. (For security reasons, do not pass session traffic through this interface.) |

High Availability Interfaces

The NetScreen-500 device has two 10/100 Base-T physical ports (HA1 and HA2) dedicated for high availability (HA) traffic. Using these ports, you can link two NetScreen-500 devices together in a redundant group, with one device acting as the master unit and the other as the backup unit. If the master unit fails, the backup unit takes over.

For information on cabling for HA, see [“Connecting the NetScreen-500 for High Availability” on page 21](#).

THE REAR PANEL

The rear panel of the NetScreen-500 device contains the power supplies and the fan module.

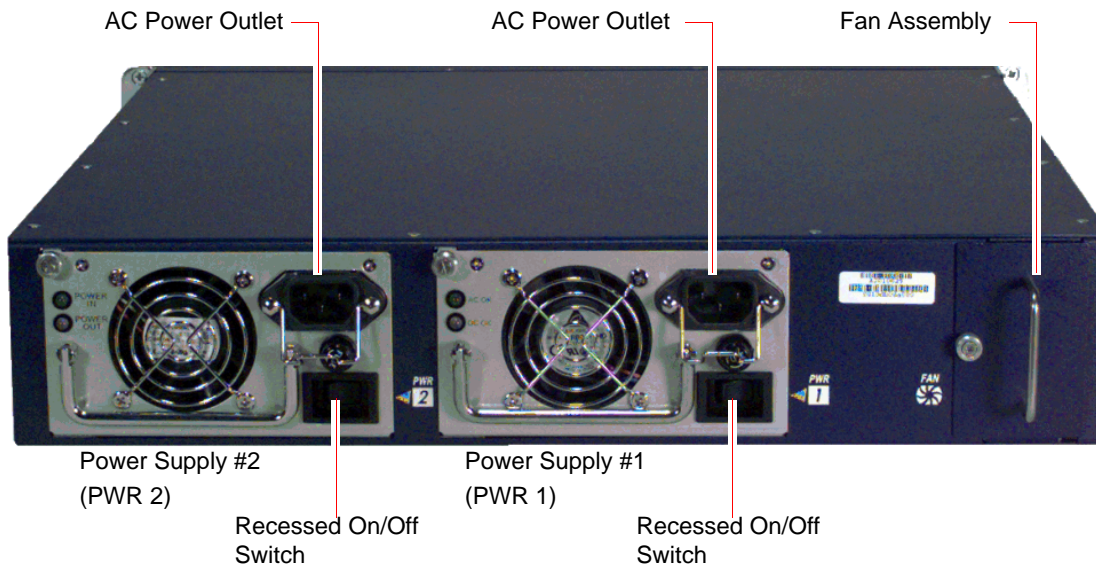

Power Supplies

The NetScreen-500 device supports two redundant, fault-tolerant and auto-switching power supplies. The power supplies are hot-swappable, so you can remove or replace one power supply without interrupting device operation.

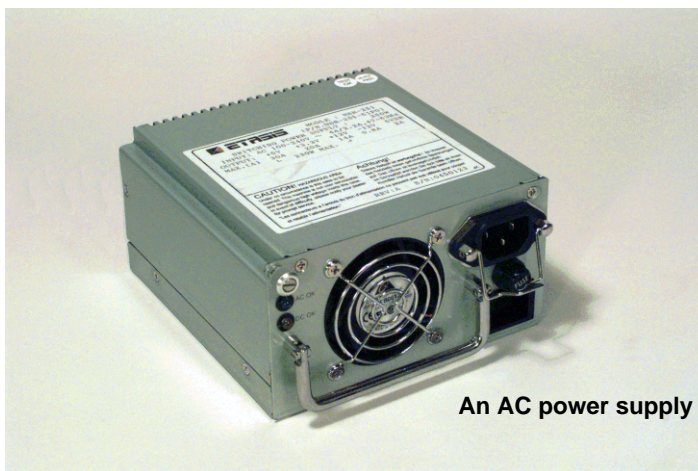

An AC power supply

You can order the NetScreen-500 device with one or two power supplies. These power supplies have the following characteristics:

- The AC power supply weighs about three pounds. The faceplate contains power LEDs, a power switch, a cooling fan vent, and a male power outlet.
- The DC power supply weighs about three pounds. The faceplate contains power LEDs, a power switch, a cooling fan vent, and a terminal block with three connectors for DC power feeds.

Although the NetScreen-500 device can run with one power supply, it is advisable to install both. This practice minimizes the likelihood of system failure due to individual power supply failure.

When the NetScreen-500 device contains two power supplies, they share the power load equally. If one power supply fails, the other assumes the full load automatically and the device sends a system alarm. The PWR 1 or PWR 2 LEDs light up as follows:

| LEDs | Purpose | Color | Meaning |
|-------|-----------------|-------|---|
| PWR 1 | Power Supply #1 | green | Power supply #1 is functioning correctly. |
| | | red | Power supply #1 failure or power bay #1 is empty. |
| PWR 2 | Power Supply #2 | green | Power supply #2 is functioning correctly. |
| | | red | Power supply #2 failure or power bay #2 is empty. |

The Fan Module

The NetScreen-500 has a four-fan module, which you can access on the left rear side of the chassis.

Fan Handle



Fan Module



Warning: If a fan stops operating due to failure or removal, the system continues to run. However, be sure to replace the fan within ten minutes. Otherwise, heat failure or permanent damage may occur.

Installing the Device

This chapter describes how to install a NetScreen-500 device in an equipment rack. Topics in this chapter include:

- “General Installation Guidelines” on page 12
- “Equipment Rack Mounting” on page 12
 - “Rack Mounting Guidelines” on page 12
 - “Equipment Rack Accessories and Required Tools” on page 13
 - “Front Mount” on page 14
 - “Mid-Mount” on page 14
 - “Rear-and-Front Mount” on page 15

Note: For safety warnings and instructions, please refer to the NetScreen Safety Guide. The instructions in this guide warn you about situations that could cause bodily injury.

GENERAL INSTALLATION GUIDELINES

Observing the following precautions can prevent injuries, equipment failures and shutdowns.

- Never assume that the power supply is disconnected from a power source. *Always* check first.
- Room temperature might not be sufficient to keep equipment at acceptable temperatures without an additional circulation system. Ensure that the room in which you operate the device has adequate air circulation.
- Do not work alone if potentially hazardous conditions exist.
- Look carefully for possible hazards in your work area, such as moist floors, ungrounded power extension cables, frayed power cords, and missing safety grounds.

Important: *Although you can place the device on a desktop for operation, it is not advisable to deploy a NetScreen-500 Series system in this manner. The best deployment technique is equipment rack mounting, described below.*

Warning: *To prevent abuse and intrusion by unauthorized personnel, install the NetScreen-500 device in a locked-room environment.*

EQUIPMENT RACK MOUNTING

The NetScreen-500 device comes with accessories for mounting the device in a standard 19-inch equipment rack.

Rack Mounting Guidelines

The location of the chassis, the layout of the equipment rack, and the security of your wiring room are crucial for proper system operation.

Use the following guidelines when setting up an equipment rack:

- Enclosed racks must have adequate ventilation. Such ventilation requires louvered sides and a fan to provide cooling air.
- When mounting a chassis in an open rack, be sure that the rack frame does not block the intake or exhaust ports. If you install the chassis on slides, check the position of the chassis when it is seated all the way into the rack.
- In an enclosed rack with a ventilation fan in the top, equipment higher in the rack can draw heat from the lower devices. Always provide adequate ventilation for equipment at the bottom of the rack.
- Baffles can isolate exhaust air from intake air. The best placement of the baffles depends on the airflow patterns in the rack.

Equipment Rack Accessories and Required Tools

Rack mounting requires the following accessories and tools:

- 1 Phillips-head screwdriver
- 4 screws to match the rack (if the thread size of the screws provided in the NetScreen-500 product package do not fit the thread size of the rack)
- The included rear slide mount kit (for the rear-and-front-mount method)

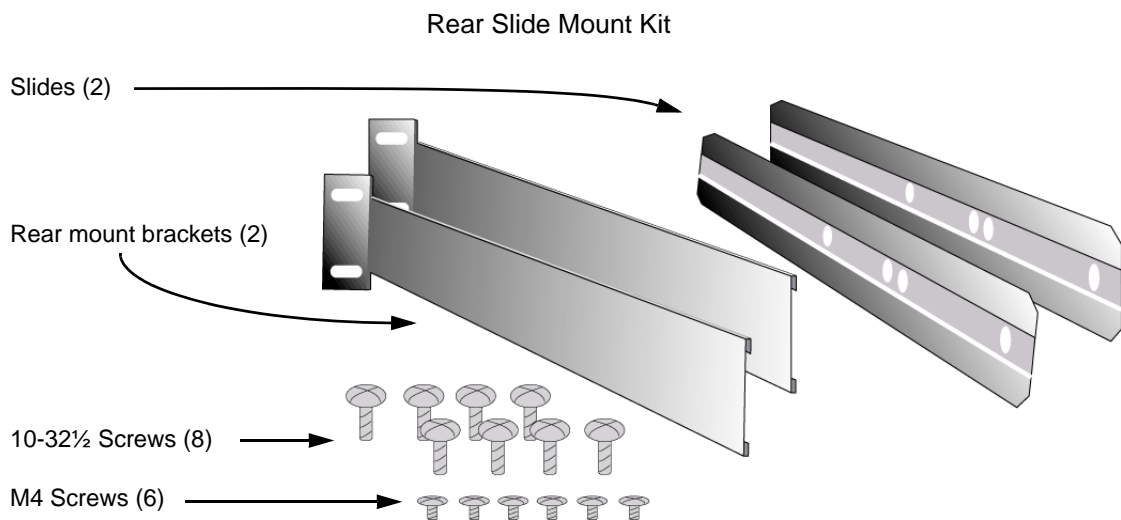

There are three ways to rack-mount the NetScreen-500:

- Front mount
- Mid-mount
- Rear-and-front mount

Note: NetScreen strongly recommends the rear-and-front rack mount configuration.

Front Mount

To front mount the NetScreen-500 device:

1. Slide the NetScreen-500 in the rack.
2. Screw the left and right plates to the rack.

Note: If the side handles interfere with the screwdriver, you might need to remove them.

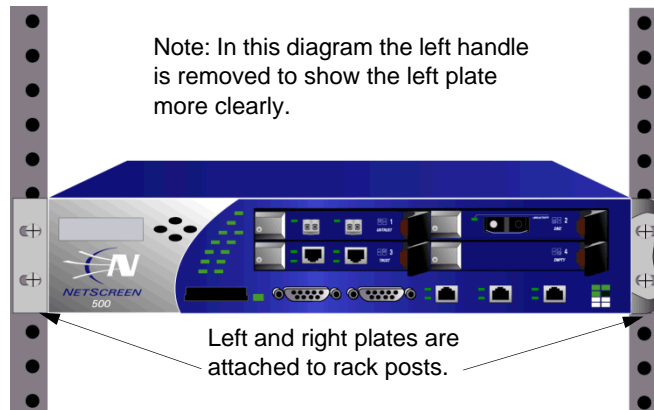

Mid-Mount

To mid-mount the NetScreen-500 device:

1. Remove the left and right side handles.
2. Unscrew the left and right plates, and then screw them to the middle of each side of the NetScreen-500 chassis.
3. Screw the left and right plates to the rack.



Rear-and-Front Mount

To mount the NetScreen-500 with support from the rear and front, use the rear slide mount kit.

1. Screw the rear mount bracket to the rear rack posts.
2. With the indented groove that runs the length of each slide facing outward, screw the slides to the middle of each side of the NetScreen-500 chassis.

Note: Depending on the depth of your equipment rack, you can attach the slides along the length of the sides or extending over the rear of the chassis.

For normal rack depth, screw the slides along the length of each side.

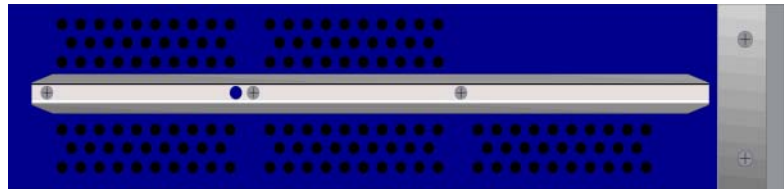

For a deeper rack, screw the slides so that they extend beyond the rear of the chassis.



3. Slip the slides into the rear mount brackets.

4. Push the NetScreen-500 forward until the left and right plates contact the front rack posts.

5. Screw the left and right plates to the rack.

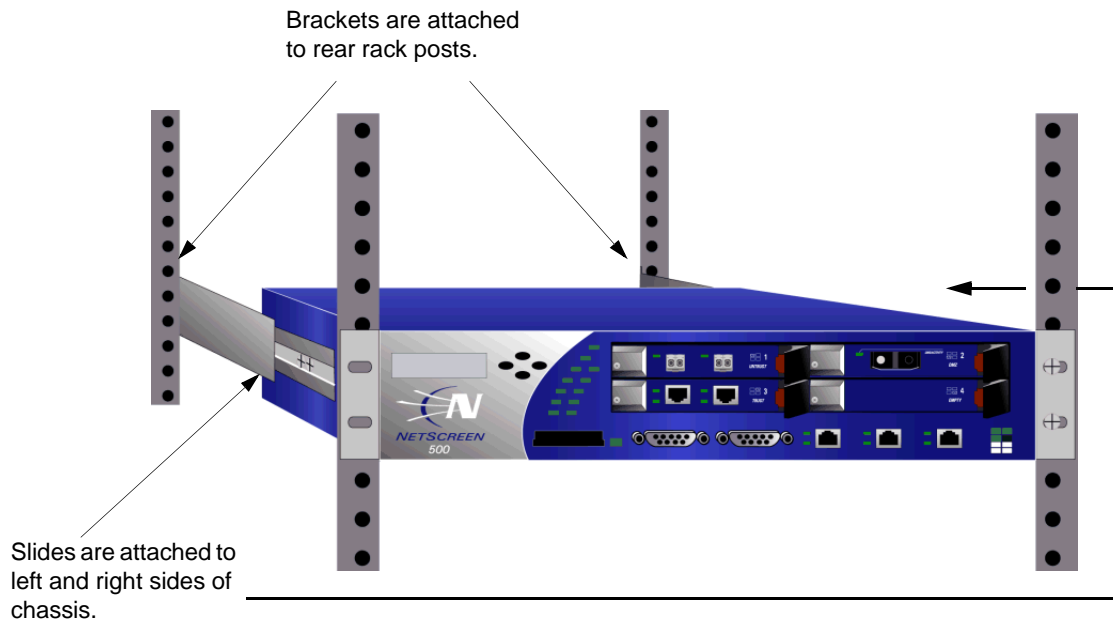

Configuring the Device

This chapter describes how to connect a NetScreen-500 to your network and perform initial configuration on the device. Topics in this chapter include:

- “Operational Modes” on page 18
 - “Transparent Mode” on page 18
 - “Route Mode” on page 18
- “The NetScreen-500 Interfaces” on page 19
 - “Configurable Interfaces” on page 19
 - “The Ethernet Interfaces” on page 19
- “Connecting to a Network” on page 20
 - “Connecting the NetScreen-500 as a Single Security Appliance” on page 20
 - “Connecting the NetScreen-500 for High Availability” on page 21
- “Performing Initial Connection and Configuration” on page 24
 - “Establishing a Console Connection” on page 24
 - “Changing Your Admin Name and Password” on page 25
 - “Setting Interface IP Addresses” on page 25
- “Configuring the Device for Telnet and WebUI Sessions” on page 28
 - “Establishing a Telnet Connection” on page 28
 - “Establishing a Dialup Management Connection” on page 28
 - “Establishing a WebUI Management Session” on page 29
 - “Configuring the Chassis Alarm” on page 29
- “Performing Initial Configuration Using the Menu System” on page 30
 - “Setting Interface IP Addresses” on page 31
- “Resetting the Device to Factory Default Settings” on page 32

Note: You must register your product at www.juniper.net/support/ so that certain ScreenOS services, such as the Deep Inspection Signature Service, can be activated on the device. After registering your product, use the WebUI or CLI to obtain the subscription for the service. For more information about registering your product and obtaining subscriptions for specific services, see the “System Parameters” chapter in Volume 2 of the NetScreen Concepts & Examples ScreenOS Reference Guide.

OPERATIONAL MODES

The NetScreen-500 supports two interface modes, Transparent mode and Route mode. The default mode is Route.

Note: *If you want to enable network address translation (NAT) at either the policy or interface level, you must first put the interfaces in Route mode. See [Route Mode](#) below.*

Transparent Mode

In Transparent mode, the NetScreen-500 operates as a Layer-2 bridge. Because the device cannot translate packet IP addresses, it cannot perform NAT. Consequently, any IP address in your trusted (local) networks must be public, routable, and accessible from untrusted (external) networks.

In Transparent mode, the IP addresses for the Trust zone and Untrust zone interfaces are 0.0.0.0, thus making the NetScreen device invisible to the network. However, the device can still perform firewall, VPN, and traffic management according to configured security policies.

Route Mode

In Route mode, the NetScreen-500 operates at Layer 3. Because you can configure each interface using an IP address and subnet mask, you can configure individual interfaces and policies to perform NAT.

- When the interface performs NAT services, the device translates the source IP address of each outgoing packet into the IP address of the untrusted port. It also replaces the source port number with a randomly-generated value. It performs translations using either Mapped IP (MIP) or Virtual IP (VIP).
- When the interface does *not* perform NAT services, the source IP address and port number in each packet header remain unchanged. Therefore, your local hosts must have public IP addresses, and you cannot assign the packet source IP addresses using MIP or VIP.

For more information on NAT, see the *NetScreen Concepts & Examples ScreenOS Reference Guide*.

Note: *Performing the setup instructions below configures your device in Route mode. To configure your device in Transparent mode, see the *NetScreen Concepts & Examples ScreenOS Reference Guide*.*

THE NETSCREEN-500 INTERFACES

The NetScreen-500 provides physical ports, each of which can serve as a physical interface. In addition, you can configure ethernet ports to serve as virtual (*logical*) interfaces.

Configurable Interfaces

The interfaces available on the NetScreen-500 are as follows.:

| Interface Type | Description |
|----------------------------|--|
| Ethernet interfaces | ethernet <i>n1/n2</i> specifies a physical ethernet interface, denoted by an interface module in a slot (<i>n1</i>) and a physical port (<i>n2</i>) on the module. |
| | ethernet <i>n1/n2.n3</i> specifies a logical interface, denoted by an interface module in a slot (<i>n1</i>), a physical port (<i>n2</i>) on the module, and a logical interface number (<i>.n3</i>). You create logical interfaces using the set interface command. |
| Layer-2 interfaces | vlan1 specifies the interface used for management traffic and VPN termination. |
| Tunnel interfaces | tunnel.<i>n</i> specifies a tunnel interface. Use this interface for VPN traffic. |
| Function interfaces | MGT specifies an interface bound to the MGT zone. You can use the MGT interface exclusively for device management, thereby separating device management traffic from user-generated network traffic. |
| | HA1 and HA2 specify the names of the dedicated HA ports. |

The Ethernet Interfaces

The ethernet interfaces are located on the interface modules (see [“Interface Modules” on page 5](#)). The interface names are as follows:

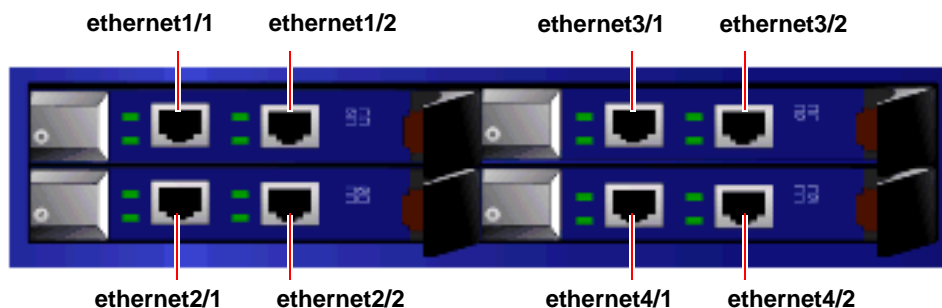

CONNECTING TO A NETWORK

The NetScreen-500 has four interface module bays, which can contain the following types of modules:

- 10/100 Mbps interface module, for 10/100 Base-T connections
- GBIC interface module, for fiber-optic connections
- Mini-GBIC interface module, for fiber-optic connections

The type of network used by your organization determines the kind of interface needed to connect the NetScreen-500. (For more information on interface modules, see “[Interface Modules](#)” on page 5.)

Note: Because of the wide variety of available routers, hubs, and switches, the cabling configuration presented here might not satisfy your network connection requirements. If the cabling suggested in this chapter does not work, try other cable configurations until an interface link light indicates an active link.

Connecting the NetScreen-500 as a Single Security Appliance

The following illustration shows typical cabling for 10/100 Base-T networks. (For fiber optic networks, use optical cables for all network connections.)

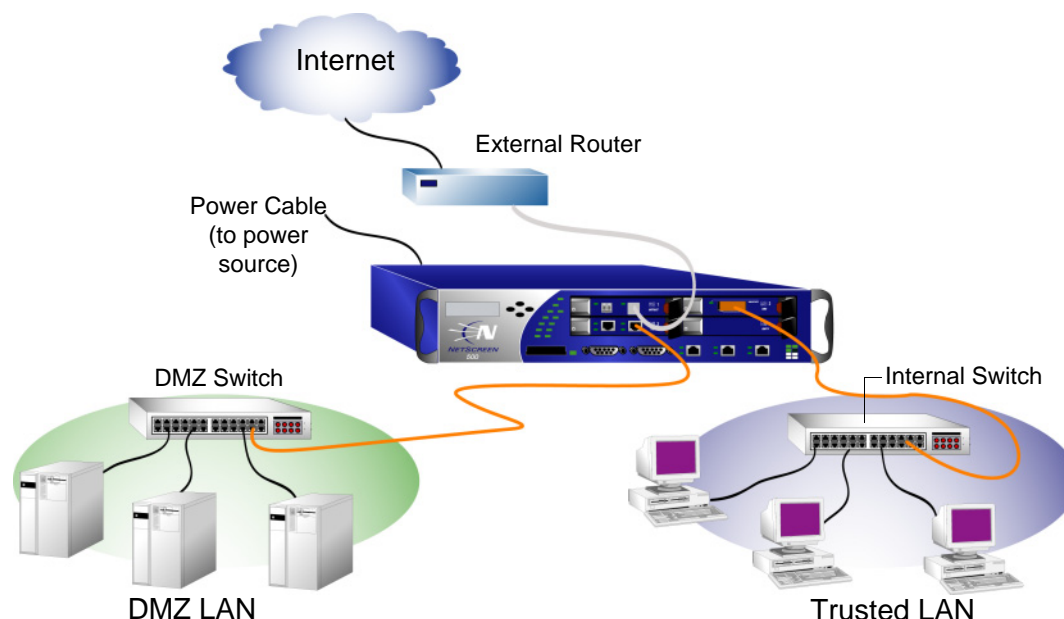

To add a NetScreen-500 device to your network:

1. (Optional) Install the NetScreen-500 device in an equipment rack (see [“Equipment Rack Mounting” on page 12](#)).
2. Make sure that the NetScreen-500 ON/OFF switch is turned off.
3. Connect the power cable, included in the product package, to the NetScreen-500 power supply and to a power source.

Note: Whenever you deploy both power supplies in a NetScreen-500 device, connect each power supply to a different power source, if possible. If one power source fails, the other source might still be operative.

4. If your network is fiber optic, connect an optical cable from the right interface of Module 3 (**ethernet3/2**) to the internal switch, router, or hub.

Note: Check your router, hub, switch, or PC documentation to see if these devices require any further configuration. In addition, see if it is necessary to switch OFF the power to any new device you add to the LAN.

5. If your network is fiber optic, connect an optical cable from the right interface of Module 1 (**ethernet1/2**) to the external router.
6. If your network is 10/100 Base-T, connect a RJ-45 cross-over cable from the right interface of Module 2 (**ethernet2/2**) to the DMZ switch, router, or hub.
7. Turn on the power.
8. After the NetScreen-500 boots up, the power, status, and link LEDs light up as follows:
 - The PWR LED for each deployed power supply glows green.
 - The STATUS LED blinks green.
 - The top Link Status LEDs for each interface glows or blinks green. (For more details about interpreting the Link Status LEDs, see [“Interface Modules” on page 5](#).)

Connecting the NetScreen-500 for High Availability

The NetScreen-500 chassis has two high-availability ports, HA1 and HA2. You can use these ports to cable two or more devices together, then configure the devices to work as a *redundant group*. A redundant group consists of a master device and at least one backup device. If the master device fails, a backup device takes over as the new master, thus avoiding interruption of services.

Note: For more information on HA configuration, see the NetScreen Concepts & Examples ScreenOS Reference Guide.

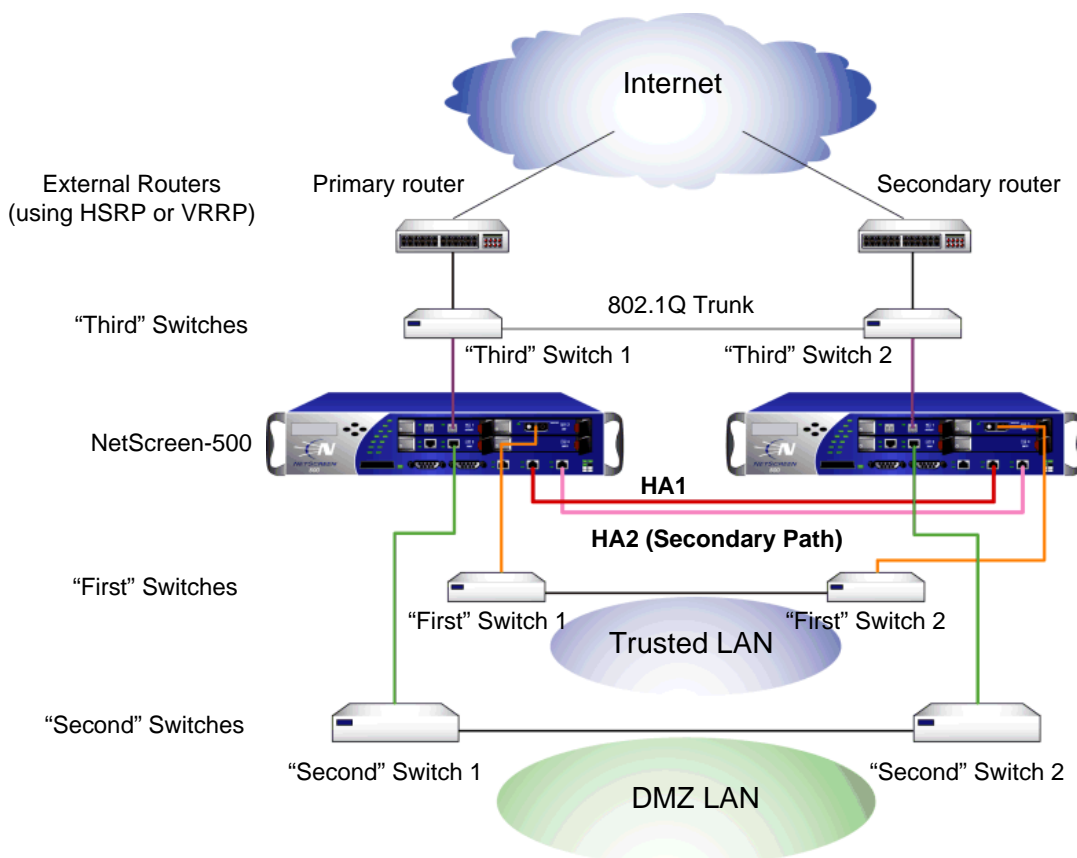

Note: The cabling instructions given below reproduce the configuration shown here. However, this is not the only possible HA configuration. In addition, the instructions assume that all physical ports and interfaces are still set at their default settings. If you have changed the port and interface configurations, the instructions below might not work properly.

To cable two NetScreen-500 devices together for HA and connect them to the network:

1. (Optional) Install the NetScreen-500 devices in an equipment rack (see [“Equipment Rack Mounting” on page 12](#)).
2. Make sure that all ON/OFF power supply switches are off.
3. Connect the power cables to each NetScreen-500 power supply and connect them to a power source.

Note: Whenever you deploy both power supplies in a NetScreen-500 device, connect each power supply to a different power source, if possible. If one power source fails, the other source might still be operative.

4. Connect a 10/100 Base-T cross-over cable from the HA1 port on one device to the HA1 port on the second device.
5. Connect a 10/100 Base-T cross-over cable from the HA2 port on one device to the HA2 port on the second device.

Master Unit

6. If your network is fiber optic, connect an optical cable from **ethernet3/2** to the switch labeled “First Switch 1” in the diagram above.
7. If your network is 10/100 Base-T, connect a cross-over cable from **ethernet2/2** to the switch labeled “Second Switch 1” in the diagram above.
8. If your network is fiber optic, connect an optical cable from **ethernet1/2** to the switch labeled “Third Switch 1” in the diagram above.

Backup Unit

9. If your network is fiber optic, connect an optical cable from **ethernet3/2** to the switch labeled “First Switch 2” in the diagram above.
10. If your network is 10/100 Base-T, connect a cross-over cable from **ethernet2/2** to the switch labeled “Second Switch 2” in the diagram above.
11. If your network is fiber optic, connect an optical cable from **ethernet1/2** to the switch labeled “Third Switch 2” in the diagram above.

Switches

12. Cable together the “First” switches (which are connected to the **ethernet3/2** ports).
13. Cable together the “Second” switches (which are connected to the **ethernet2/2** ports).
14. Cable together the “Third” switches (which are connected to the **ethernet1/2** ports).
15. Cable to routers the “Third” switches (which are connected to the **ethernet1/2** ports).

Note: The switch ports should be defined as 802.1Q trunk ports, and the external routers must be able to use either Hot Standby Router Protocol (HSRP) or Virtual Router Redundancy Protocol (VRRP). For the best configuration method, see the documentation for your switch or router.

16. Turn on both NetScreen-500 devices.

PERFORMING INITIAL CONNECTION AND CONFIGURATION

To establish the first console session with the NetScreen-500 device, use a vt100 terminal emulator program through the provided DB9 serial port connector.

Establishing a Console Connection

To establish an initial console session:

1. Plug the female end of the supplied DB-9 serial cable into the serial port of your PC. (Be sure that the DB-9 clip is seated properly and secured with the thumbscrews.)
2. Plug the male end of the DB-9 serial cable into the Console port of the NetScreen-500 device. (Be sure that the DB-9 clip is seated properly and secured with the thumbscrews.)
3. Launch a Command Line Interface (CLI) session between your PC and the NetScreen-500 device using a standard serial terminal emulation program such as Hilgraeve Hyperterminal (provided with your Windows PC). The settings should be as follows:
 - Baud Rate to **9600**
 - Parity to **No**
 - Data Bits to **8**
 - Stop Bit to **1**
 - Flow Control to **none**
4. Press the ENTER key to see the login prompt.
5. At the login prompt, type `netscreen`.
6. At the password prompt, type `netscreen`.

Note: Use lowercase letters only. Both login and password are case-sensitive.

7. (Optional) By default, the console times out and terminates automatically after 10 minutes of idle time. To change this timeout interval, execute the following command:

set console timeout *number*

where *number* is the length of idle time in minutes before session termination. To prevent any automatic termination, specify a value of zero.

Changing Your Admin Name and Password

Because all NetScreen products use the same admin name and password (**netscreen**), it is highly advisable to change your admin name and password immediately. Enter the following commands:

```
set admin name name_str
set admin password pswd_str
save
```

For information on creating different levels of administrators, see the Administration volume in the *NetScreen Concepts and Examples ScreenOS Reference Guide*.

Setting Interface IP Addresses

The default IP address and subnet mask settings for the NetScreen-500 interfaces are 0.0.0.0 and 0.0.0.0, respectively. (The exception is the MGT interface, as described below in [Setting the IP Address of the Management Interface](#).)

Through the CLI, you can execute commands that set IP address and subnet mask values for most of the physical interfaces. Use the CLI **save** command to save your configuration.

Viewing Current Interface Settings

To begin the configuration process, it is advisable to view existing port settings by executing the following command:

```
get interface
```

This command displays interface names, IP addresses, MAC addresses, and other useful information.

Setting the IP Address of the Management Interface

The default IP address and subnet mask settings for the MGT interface are 192.168.1.1 and 255.255.255.0, respectively. To access the MGT interface, you must change the IP address and subnet mask of the MGT interface to match your current network. NetScreen recommends using the MGT interface exclusively for out of band management.

To set the IP address of the MGT port:

1. Choose an unused IP address within the current address range of your Local Area Network.
2. Set the MGT port to this unused IP address by executing the following command:

```
set interface mgt ip ip_addr/mask
```

For example, to set the IP address and subnet mask of the MGT port to 10.100.2.183 and 16, respectively:

```
set interface mgt ip 10.100.2.183/16
```

3. To confirm the new port settings, execute the following command:
`get interface mgt`

Setting the IP Address for the Trust Zone Interface

The NetScreen-500 device usually communicates with your protected network through an interface bound to the Trust zone. To allow an interface to communicate with internal devices, you must assign it the IP address and netmask for your protected network.

To set up the **ethernet3/2** interface to communicate with your trusted network:

1. Determine the IP address and netmask of your trusted network.
2. Set the **ethernet3/2** interface to the Trust zone by executing the following command:
`set interface ethernet3/2 zone trust`
3. Set the IP address and netmask by executing the following command:
`set interface ethernet3/2 ip ip_addr/mask`
where *ip_addr* is the IP address and *mask* is the netmask. For example, to set the IP address and netmask of the **ethernet3** interface to 10.250.2.1/16:
`set interface ethernet3/2 ip 10.250.2.1/16`
4. (Optional) To confirm the new port settings, execute the following command:
`get interface ethernet3/2`

Setting the IP Address for the Untrust Zone Interface

The NetScreen-500 device usually communicates with external (untrusted) devices through an interface bound to the Untrust zone. To allow an interface to communicate with external devices, you must assign it a public IP address.

To set up the **ethernet1/2** interface to communicate with external devices:

1. Choose an unused public IP address and netmask.
2. Set the **ethernet1/2** interface to the Untrust zone by executing the following command:
`set interface ethernet1/2 zone untrust`
3. Set the IP address and netmask by executing the following command:
`set interface ethernet1/2 ip ip_addr/mask`
where *ip_addr* is the IP address and *mask* is the netmask. For example, to set the IP address and netmask of the **ethernet2/3** interface to 172.16.20.1/16:
`set interface ethernet1/2 ip 172.16.20.1/16`
4. (Optional) To confirm the new interface settings, execute the following command:
`get interface ethernet1/2`

Allowing Outbound Traffic

By default, the NetScreen-500 device does not allow any interzone traffic, nor does it allow traffic to or from the DMZ. To permit (or deny) traffic, you must create policies.

The following CLI command creates a policy that permits all kinds of outbound traffic, from any host in the Trust zone to any destination in the Untrust zone.

```
set policy from trust to untrust any any any permit
```

Save your policy configuration with the following command:

```
save
```

Note: Your network might require a more restrictive policy than the one created in the example above. The example is *NOT* a requirement for initial configuration. For detailed information about policies, see the NetScreen Concepts & Examples ScreenOS Reference Guide.

CONFIGURING THE DEVICE FOR TELNET AND WEBUI SESSIONS

You can use Telnet (or dialup) to establish console sessions with the NetScreen-500 device. In addition, you can start management sessions using the NetScreen WebUI, a web-based WebUI management application.

Establishing a Telnet Connection

To establish a Telnet connection with the NetScreen-500, perform the following steps:

1. Connect a RJ-45 cable from the MGT interface to the internal switch, router, or hub in your LAN (see “[Setting the IP Address for the Trust Zone Interface](#)” on [page 26](#)).
2. Open a Telnet session, specifying the current MGT interface IP address. For example, in Windows, click **Start > Run**, enter `telnet ip_addr` (where `ip_addr` is the IP address of the MGT interface), and then click **OK**.

For example, if the MGT interface has an IP address of 10.100.2.183, enter:

```
telnet 10.100.2.183
```

3. At the Username prompt, type your user name (default is **netscreen**).
4. At the Password prompt, type your password (default is **netscreen**).

***Note:** Use lowercase letters only. Both Username and Password are case-sensitive.*

5. (Optional) By default, the console times out and terminates automatically after 10 minutes of idle time. To change this timeout interval, execute the following command:

```
set console timeout number
```

where *number* is the length of idle time in minutes before session termination. To prevent any automatic termination, specify a value of zero.

Establishing a Dialup Management Connection

Each NetScreen-500 device provides a modem port that allows you to establish a remote console session using a dialup connection through a 9600 bps modem. Dialing into the modem establishes a dialup console connection.

***Note:** The Terminal type for dialup sessions must be vt100. For example, in Hilgraeve HyperTerminal (a commonly-used terminal application), click **Connect**, select **Remote System** from the drop-down menu, then select **vt100** from the Term Type menu.*

Establishing a WebUI Management Session

To access the NetScreen-500 device with the WebUI management application:

1. After cabling the NS-500 to the network as described in “[Connecting to a Network](#)” on page 20, cable the MGT interface to a network device, such as a router, switch, or hub. Optionally, cable it directly to the network interface card (NIC) of your workstation. (The IP address of your workstation must be in the same subnet as the IP address of the MGT interface.)
2. Launch your browser, enter the IP address of the MGT interface in the URL field, and then press **Enter**.

For example, if you assigned the MGT interface an IP address of 10.100.2.183/16, enter the following:

10.100.2.183

The NetScreen WebUI software displays the Login prompt.

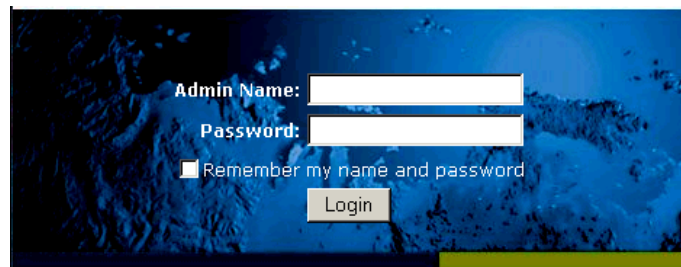

3. Enter **netscreen** in both the **Admin Name** and **Password** fields, then click **Login**. (Use lowercase letters only. The Admin Name and Password fields are both case sensitive.)

The NetScreen WebUI application window appears.

Configuring the Chassis Alarm

The NetScreen-500 allows you to configure the chassis alarm, an audible warning that sounds when a system failure or hazardous event occurs.

To specify which failures and events trigger the chassis alarm:

1. Configure the audible alarms by executing the following command:

```
set audible-alarm string
```

where *string* can be any of the following keywords:

- **all** enables all chassis alarms.
- **fan-failed** sets the chassis alarm to sound when a fan fails.
- **module-failed** sets the chassis alarm to sound when an interface module fails.

- **power-failed** sets the chassis alarm to sound when a power supply fails.
- **temperature** sets the chassis alarm to sound when the temperature goes outside of the acceptable range.

PERFORMING INITIAL CONFIGURATION USING THE MENU SYSTEM

Through the control pad menu interface, you can configure many device settings, including system and interface IP addresses.

***Note:** You cannot use the control pad menu system to create a policy, change the administrator's login name and password, or test the configuration. To perform these tasks you must use either the WebUI or CLI. Even so, the control pad menu system is a convenient tool for configuring interfaces and performing other initial configurations on site.*

For more information on the control pad menu system, see [“LCD and Control Pad Menu Interface” on page 2](#).

Setting Interface IP Addresses

The most important initial configuration task you can perform using the control pad menu interface is setting MGT, vlan1, and Ethernet interface IP addresses and subnet masks.

Setting the MGT Interface IP Address and Netmask

1. Navigate to the following menu location:
 1. Setting > 12. Interface > 128. MGT > 1281. IF IP:
2. Press the RIGHT control key.

The current MGT interface IP address appears, with the cursor flashing over the far left digit.

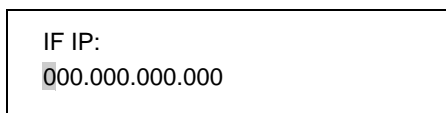

```
IF IP:
000.000.000.000
```

3. Use the UP and DOWN control keys to scroll through digits 0-2. When you reach the digit you want, move to the next digit by pressing the RIGHT control key.
4. Repeat Step 3 until you have specified all digits for the MGT interface IP address.

5. With the cursor positioned on the far right digit, press the RIGHT control key. When prompted to confirm the new MGT IP address, press the RIGHT control key again.
6. Navigate to the following menu location:
 1. Setting > 12. Interface > 128. MGT > 1282. IF Netmask:
7. Press the RIGHT control key, and select the digits for the MGT interface netmask as you did for the IP address.

Setting the VLAN1 IP Address for Transparent Mode

To manage the NetScreen device over a network connection, you must change the vlan1 IP address from its default (192.168.1.1) to one that is appropriate for your network.

To change the system IP address:

1. Setting > 12. Interface > 129. vlan1 > 1291. IF Netmask:
2. Press the RIGHT control key.

The current vlan1 interface IP address appears, with the cursor flashing over the far left digit.

```
IF IP:
192.168.001.001
```

3. Use the UP and DOWN control keys to scroll through digits 0-2. When you reach the digit you want, move to the next digit by pressing the RIGHT control key.
4. Repeat Step 3 until you have specified all digits for the vlan1 interface IP address.
5. With the cursor positioned on the far right digit, press the RIGHT control key. When prompted to confirm the new vlan1 IP address, press the RIGHT control key again.

Setting Interface IP Addresses

1. 1. Setting > 12. Interface > 12*n*. ethernet*n1/n2* > 12*n1*. IF IP:

where *n* uniquely identifies the interface, *n1* identifies the interface module slot, and *n2* represents a physical interface on the module.
2. Press the RIGHT control key.

The current ethernet interface IP address appears, with the cursor flashing over the far left digit.

```
IF IP:
000.000.000.000
```

3. Use the UP and DOWN control keys to scroll through digits 0-2. When you reach the digit you want, move to the next digit by pressing the RIGHT control key.
4. Repeat Step 3 until you have specified all digits for the ethernet interface IP address.
5. With the cursor positioned on the far right digit, press the RIGHT control key. When prompted to confirm the new ethernet IP address, press the RIGHT control key again.
6. Navigate to the following menu location:
 1. Setting > 12. Interface > 12*n*. ethernet*n1/n2* > 12*n2*. IF Netmask:
where *n* uniquely identifies the interface, *n1* identifies the interface module slot, and *n2* represents a physical interface on the module.
7. Press the RIGHT control key, and select the digits for the ethernet interface netmask as you did for the IP address.

RESETTING THE DEVICE TO FACTORY DEFAULT SETTINGS

If you lose the admin password, you can use the following procedure to reset the NetScreen device to its default settings. This destroys any existing configurations, but restores access to the device. To perform this operation, you need to make a console connection, as described in “[Establishing a Console Connection](#)” on page 24.

Note: By default the device recovery feature is enabled. You can disable it by entering the following CLI command: **unset admin device-reset**.

1. At the login prompt, type the serial number of the device.
2. At the password prompt, type the serial number again.

The following message appears:

!!! Lost Password Reset !!! You have initiated a command to reset the device to factory defaults, clearing all current configuration, keys and settings. Would you like to continue? y/[n]

3. Press the **y** key.

The following message appears:

!! Reconfirm Lost Password Reset !! If you continue, the entire configuration of the device will be erased. In addition, a permanent counter will be incremented to signify that this device has been reset. This is your last chance to cancel this command. If you proceed, the device will return to factory default configuration, which is: System IP: 192.168.1.1; username: netscreen; password: netscreen. Would you like to continue? y/[n]

4. Press the **y** key to reset the device.

You can now login in using *netscreen* as the default username and password.

Servicing the Device

This chapter describes service and maintenance procedures for your NetScreen-500 system. Topics in this chapter include:

- “Removing and Inserting Interface Modules” on page 34
 - “Inserting Interface Modules” on page 34
 - “Removing Interface Modules” on page 37
- “Installing Power Supplies” on page 38
 - “Wiring the DC Power Supplies” on page 38
 - “Replacing a DC Power Supply” on page 39
 - “Replacing an AC Power Supply” on page 40
- “Replacing the Fan Module” on page 41
- “Connecting and Disconnecting Gigabit Ethernet Cables” on page 43
- “Removing and Installing a Mini-GBIC Transceiver” on page 43
- “Removing and Installing a GBIC Transceiver” on page 44

Note: For safety warnings and instructions, please refer to the NetScreen Safety Guide. The instructions in this guide warn you about situations that could cause bodily injury.

REMOVING AND INSERTING INTERFACE MODULES

The NetScreen-500 has four interface module bays. The supplied modules are pre-installed, although they are removable and replaceable.

There are three types of interface modules:

- 10/100 Base-T module
- GigaBit Interface Connector (GBIC) module
- Mini-GBIC Interface Connector module

You can use these interface modules in whatever combination and arrangement suits the special needs of your network infrastructure.

Inserting Interface Modules

To insert an interface module into a module bay:

Warning: When inserting or removing interface modules, be sure that the power is OFF.

1. Align the side edges of the card with the grooves in the side walls of the bay.

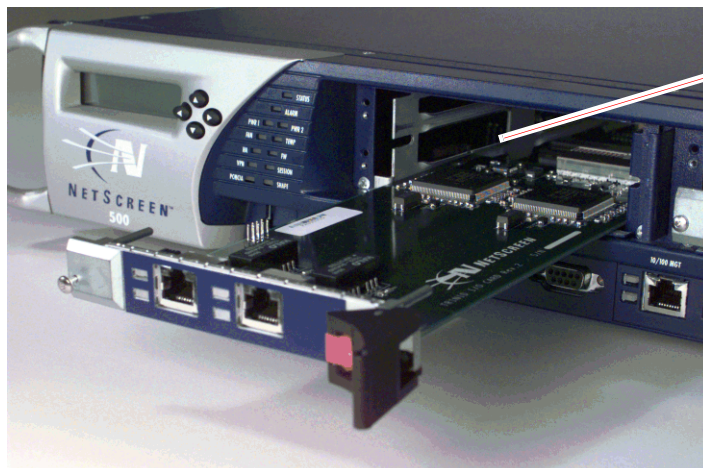

Align edge
of module
with grooves.

2. Slide the card in until the groove in the black latch contacts the ridge at the outermost edge of the right bay wall.

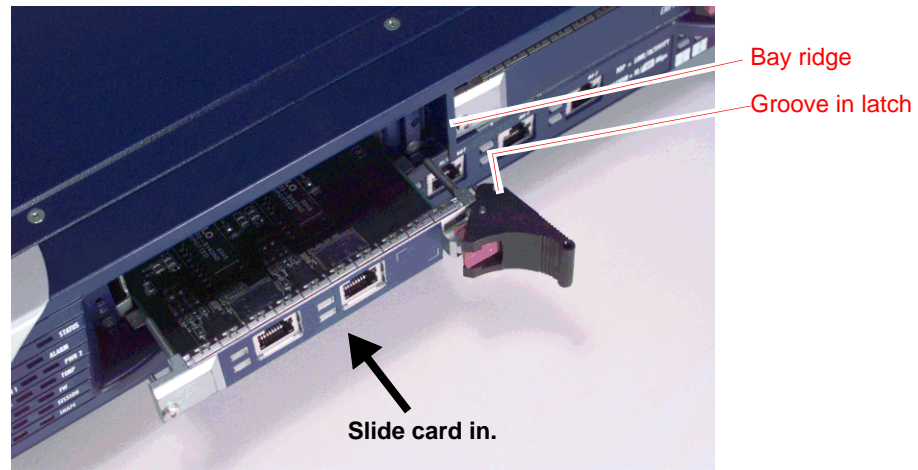

Warning: When inserting and removing a card in bay 2, take care that the electromagnetic interference (EMI) fingers located along the top edge of the front wall of the interface module do not catch on the lower edge of the card above it in bay 1.

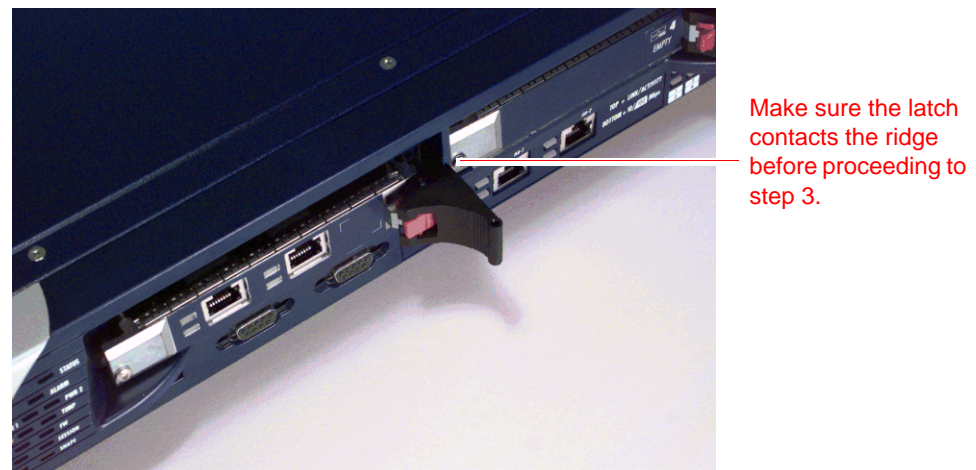

3. Simultaneously push in the front left corner of the module (with your left thumb) and push the latch in and slightly toward your left (with your right thumb) until the red locking tab clicks into place.



Important: If you push the latch before it contacts the ridge on the bay wall, the locking tab clicks into place prematurely and you will not be able to seat the interface module properly.

4. Using a Phillips screwdriver, screw in the captive screw on the front left corner.



Removing Interface Modules

To remove an interface module from a bay:

Warning: While inserting or removing interface modules, be sure that the power is OFF.

1. Using a Phillips screwdriver, unscrew the captive screw on the front left corner of the interface module.
2. Push the red locking tab to the right, releasing the black latch.



3. Pull the latch to the right, popping the card free.



4. Gripping the latch, gently slide the card straight out.

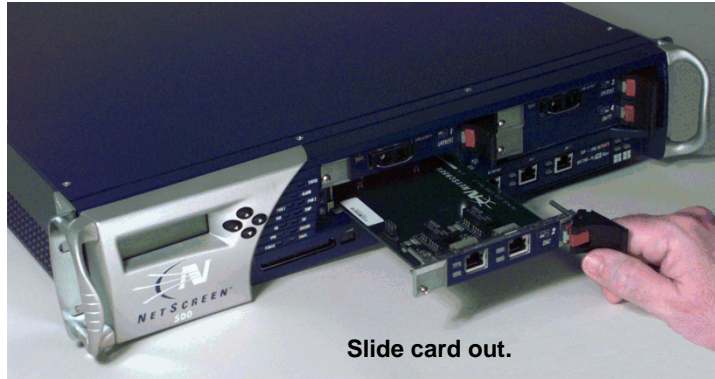

Warning: When inserting and removing a card in bay 2, take care that the electromagnetic interference (EMI) fingers located along the top edge of the front wall of the interface module do not catch on the lower edge of the card above it in bay 1.

INSTALLING POWER SUPPLIES

Although the NetScreen-500 device can run with one power supply, it is advisable to install both to minimize the likelihood of system failure due to individual power supply failure.

Warning: You must shut off current to the DC feed wires before connecting the wires to the power supplies. Also, make sure that the ON/OFF power supply switches are in the OFF position (right side pressed in).

Wiring the DC Power Supplies

The DC power supplies are located in the back of the chassis.

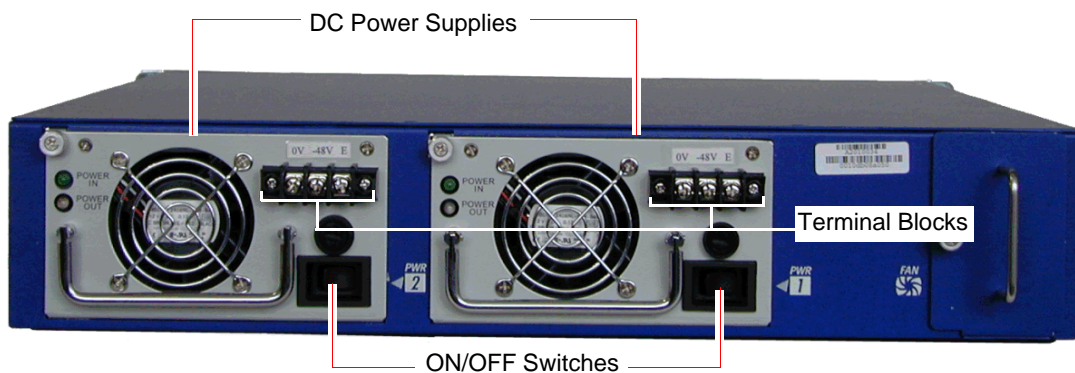

To connect DC power feeds to the terminal blocks:

1. Loosen the three retaining screws on each terminal block.
2. Insert the 0V DC return wire into the left power connector.
3. Insert the -48V DC power feed wire into the middle power connector.
4. Insert the ground wire into the ground (E) connector at the right.
5. Fasten the screws over the connectors and ground.

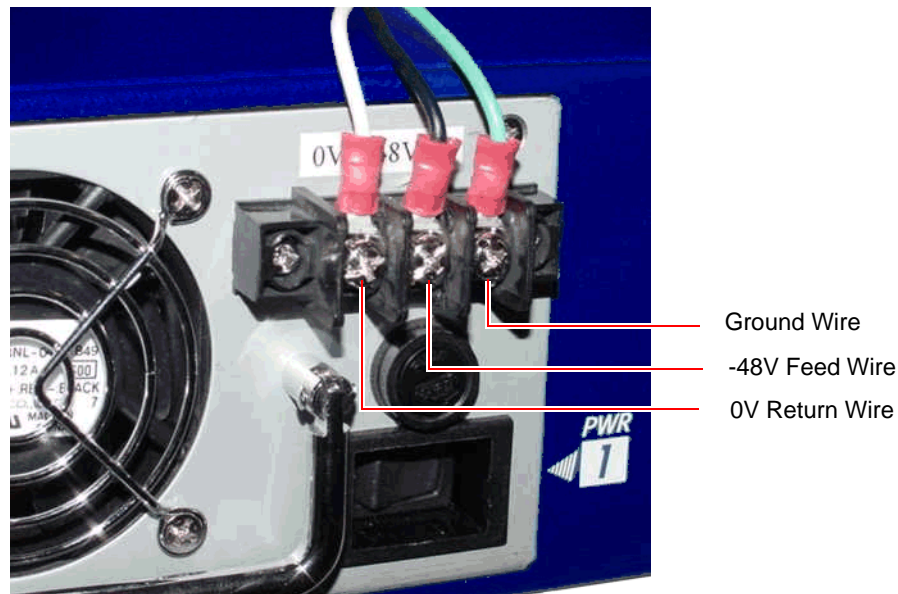

Replacing a DC Power Supply

Warning: You must shut off current to the DC feed wires leading to the power supply that you want to replace. Also, make sure that the ON/OFF switch on the power supply is in the OFF position (right side pressed in).

To replace one of the DC power supplies, do the following:

1. Loosen the three retaining screws on the terminal block.
2. Remove the feed wires.
3. Turn the thumbscrew counterclockwise to release the power supply.
4. Lift the handle and, gripping the handle, pull the power supply straight out.
5. Insert the new power supply into the bay.
6. Secure the power supply in place by tightening the thumbscrew clockwise.

Reconnect the wires as explained in [“Wiring the DC Power Supplies” on page 38](#).

Replacing an AC Power Supply

To replace an AC power supply:

1. Turn OFF the power supply.
2. Lift the AC power cord retainer clip.

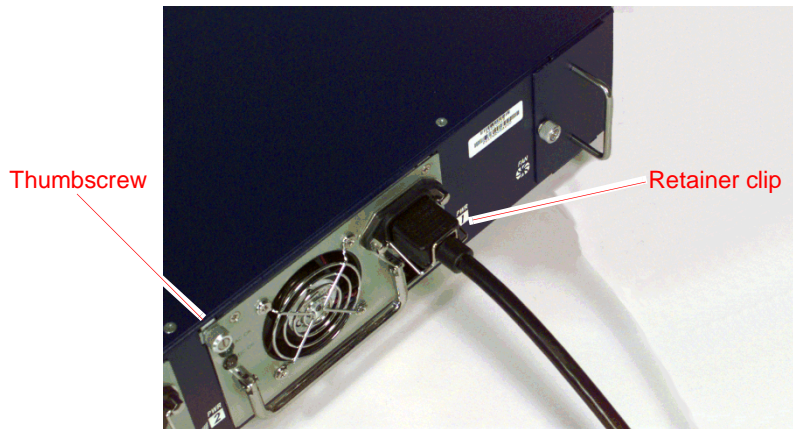

3. Unplug the cord from the power supply.
4. Turn the thumbscrew counterclockwise to release the power supply.
5. Lift the handle and, gripping the handle, gently pull the power supply straight out.

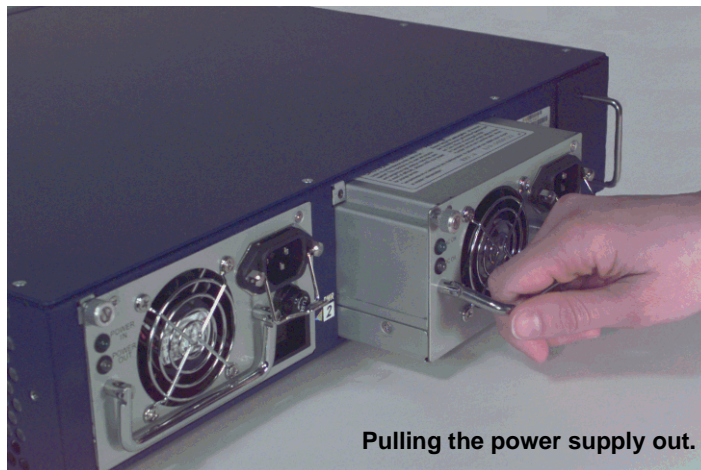

6. Insert the new power supply into the bay.
7. Secure it in place by tightening the thumbscrew clockwise.
8. Lift the retainer clip, and plug the power cord into the power supply.
9. Press the retainer clip over the cord, securing it in place.

Press retainer clip
down on both sides
of the power cord.

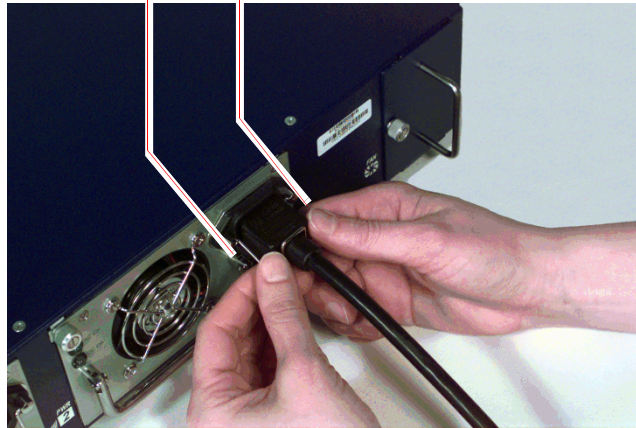

REPLACING THE FAN MODULE

Note: During the one-year warranty period, you can obtain a replacement fan module by contacting NetScreen Technical support. After the warranty period, contact the NetScreen Sales department.

You only need to replace the fan module when a failure occurs. When this happens, the FAN LED glows red, and the device generates an event alarm and a SNMP trap.

To remove the fan module:

1. Turn the captive thumbscrew counterclockwise.

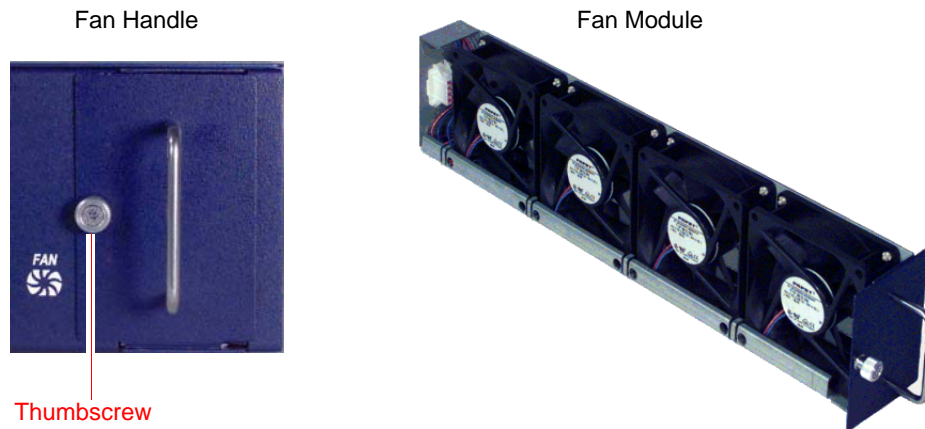

2. Grip the handle and gently slide the assembly straight out.

Warning: Do not remove the fan module while the fans are still spinning.

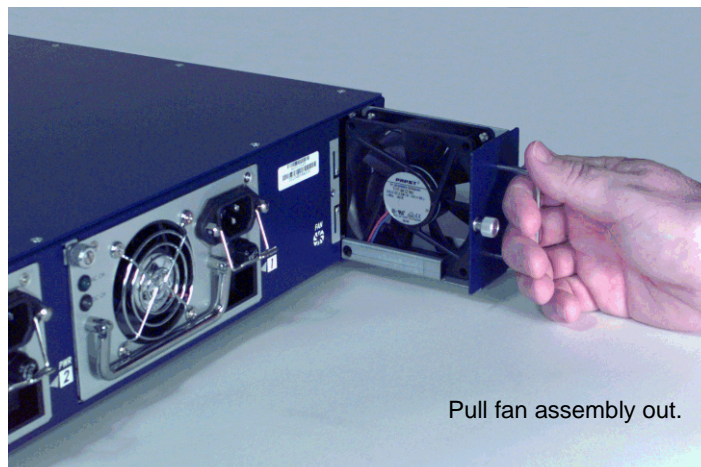

3. Insert the new fan module in the fan bay, and push it straight in.
4. Secure the fan module in place by tightening the thumbscrew clockwise.

CONNECTING AND DISCONNECTING GIGABIT ETHERNET CABLES

To connect a gigabit ethernet cable to a mini-GBIC connector transceiver port:

1. Hold the cable clip firmly but gently between your thumb and forefinger, with your thumb on top of the clip and your finger under the clip. (Do not depress the clip ejector on top of the clip.)
2. Slide the clip into the transceiver port until it clicks into place.

Because the fit is close, you may have to apply some force to seat the clip. To avoid clip breakage, apply force evenly and gently.

To remove the cable from the transceiver port:

1. Make sure the black transceiver ejector under the port is not pressed in. Otherwise, when you attempt to remove the cable, the transceiver might come out with the cable still attached.
2. Hold the cable clip firmly but gently between your thumb and forefinger, with your thumb on top of the clip and your finger under the clip.
3. Using your thumb, gently press the clip ejector on top of the clip, down and forward. This action loosens the clip from the transceiver port.
4. Gently but firmly, pull the clip from the transceiver port.

REMOVING AND INSTALLING A MINI-GBIC TRANSCEIVER

To remove a mini-GBIC-transceiver from an interface module:

1. Push in the black ejector (located on the underside of the transceiver) until it locks into place, disengaging the transceiver.
2. Grasp the transceiver at both sides and, firmly but gently, pull the transceiver toward you to remove it from the module.

To install a mini-GBIC transceiver into a module:

1. Grasp the transceiver with the label facing up, and insert it into the transceiver slot until seated.
2. Check to see if the black transceiver ejector extends fully out to the front of the ejector slot, flush with the port portion of the transceiver.

REMOVING AND INSTALLING A GBIC TRANSCEIVER

There are two types of GBIC transceivers: one has a locking handle to secure the GBIC in the module, the other has clips on either side of the GBIC. To remove a GBIC transceiver from a module:

- If the GBIC has a locking handle, lift the handle up first before sliding the GBIC out of the slot.
- If the GBIC has clips on either side, squeeze the clips and slide the GBIC out of the slot.

To install a GBIC transceiver:

- If the GBIC has a locking handle, slide the GBIC into the slot and then lower the handle on the GBIC.
- If the GBIC has clips on either side, squeeze the clips and slide the GBIC into the slot.

Specifications

A

This appendix provides general system specifications for the NetScreen-500 system.

- [“NetScreen-500 Attributes” on page A-II](#)
- [“Electrical Specification” on page A-II](#)
- [“Environmental” on page A-II](#)
- [“FIPS Certification” on page A-II](#)
- [“Safety Certifications” on page A-II](#)
- [“EMI Certifications” on page A-II](#)
- [“Connectors” on page A-III](#)
- [“Sessions” on page A-III](#)

NETSCREEN-500 ATTRIBUTES

Height: 3.5 inches (8.9 cm)

Depth: 17 inches (43 cm)

Width: 17.5 inches (44.5 cm)

Weight: 27 pounds (12 kg)

ELECTRICAL SPECIFICATION

AC voltage: 100 - 240 VAC +/- 10%

DC voltage: -36 to -60 VDC

AC Watts: 100 Watts

DC Watts: 100 Watts

Input frequency: 47 - 63 Hz

Fuse Rating: 5 Amps / 250 Volts

ENVIRONMENTAL

| Temperature | Operating |
|--------------------------|-----------------------|
| Normal altitude | 32-122° F, 0° - 50° C |
| Relative humidity | 10-90% |
| Non-condensing | 10-90% |

The maximum normal altitude is 12,000 ft (0-3,660 m)

FIPS CERTIFICATION

FIPS 140-1 Level 1

SAFETY CERTIFICATIONS

CSA

EMI CERTIFICATIONS

FCC class A, BSMI, CE class A, C-Tick, VCCI class A

CONNECTORS

The RJ-45 twisted-pair ports are compatible with the IEEE 802.3 Type 10/100 Base-T standard.

The mini-gigabit transceivers used in NetScreen-500 modules are Shortwave or SX type, so they are good for up to 550 meters. (This varies by manufacturer.) The limit is 850 for the optic LC-type connector. The mini-Gigabit transceivers are compatible with the IEEE 802.3z Gigabit Ethernet standard.

The following table lists media types and distances for the different types of connectors used in the NetScreen-500.

| Standard | Media Type | Mhz/Km Rating | Maximum Distance |
|-------------|---|---------------|------------------|
| 1000Base-SX | 50/125µm Multimode Fiber | 400 | 500 m |
| | 50/125µm Multimode Fiber | 500 | 550 m |
| | 62.5/125µm Multimode Fiber | 160 | 220 m |
| | 62.5/125µm Multimode Fiber | 200 | 275 m |
| 1000Base-LX | 50/125µm Multimode Fiber | 400 | 550 m |
| | 62.5/125µm Multimode Fiber | 500 | 550 m |
| | 9/125µ Single-mode Fiber | | 10,000 m |
| 100Base-TX | Category 5 and higher Unshielded Twisted Pair (UTP) Cable | | 100 m |

SESSIONS

Maximum concurrent sessions: 250,000

Maximum new sessions/second: 17,000

Index

A

asset recovery 32

C

cabling

network interfaces 28

power supply 21, 22

changing login and password 25

configuration

saving to PC card (CLI) 7

console

changing timeout 24, 28

F

fan assembly 9–42

G

guide organization v

H

HA 21–23

ports 7

hardware

dimensions A-II

I

installation guidelines 12

installing modules 9

interface modules 35, 38

indicator LEDs 6

removing 37

L

LEDs

ALARM 3

FAN 4

FW 4

HA 4

link Status 6

PCMCIA 4

PWR 1 4, 9

PWR 2 4, 9

SESSION 4

SHAPE 4

STATUS 3

TEMP 4

VPN 4

logging on 28

login

changing 25

M

management

session 28, 29

software, logging on 30

management port

setting an IP address 25

MGT port 7

modem port 7

modules

allowable slots 9

installing 9

N

NetScreen Publications vi

P

password

changing 25

resetting 32

PC card 7

port settings, viewing 25

ports

console 7

HA 7

MGT 7

modem 7

power supplies 9

AC 9

replacing 40

DC 9

- ground posts 39
- replacing 39
- terminal blocks 39
- wiring 38

R

- rack 12
- rack installation guidelines 12
- rack mounting 12
 - front-mount 14
 - mid-mount 14
 - rear and front mount 15
 - rear slide mount kit 13

- reset 32

S

- software, saving to PC card (CLI) 7
- status LEDs 6

T

- transparent mode 18

V

- ventilation 12
- viewing port settings 25